

Design and Analysis various parameters of I.C. Engine fins

S. Baskaran^a, R. Santhosh Kumar^b, G. Sathish Kumar^c, R. Saran Kumar^d, B. Thiru moorthy^e

^a Assiatant Professor, Department of Mechanical Engineering, K S R Institute for Engineering and Technology, Tiruchengode-637215, Tamilnadu, India.

^{b,c,d,e} UG Student, Department of Mechanical Engineering, K S R Institute for Engineering and Technology, Tiruchengode-637215, Tamilnadu, India.

***Corresponding Author**

baskaran1207@gmail.com

(S. Baskaran)

Tel.: +91 9942332115

ABSTRACT: The engine cylinder is one of the major automobile components which is subjected to high temperature variations. In order to cool the cylinder, an extended surface which is commonly known as fins are provided on cylinder to increase the rate of heat transfer from the system to surrounding. It is helpful to know the heat dissipation inside cylinder. In this project, we are considering the Apache 160cc model fins to increase the heat transfer. Presently material used for manufacturing fin body is Aluminium Alloy 6061 which has thermal conductivity of 151–202 W/m k. In this thesis, using copper alloy which has thermal conductivity of 401w/m k, magnesium alloy which has thermal conductivity of 156w/m k are also analysed. Fins with various thickness and configuration of fins such as fins with holes, rectangular notches and V-notch are also modelled by CATIA V5R20 to increase the heat dissipation rate by selecting suitable material. Thermal analysis on the I.C. Engine fin is done by ANSYS workbench 14.0

Keywords: Thermal conductivity; heat dissipation rate; thickness and materials.

1 Introduction

In internal combustion engine, combustion of air and fuel take place inside the engine cylinder and hot gases are produced. The temperature of gases will be around 2300-2500°C. This is very high temperature and may result into burning of oil film between the moving parts and may results it seizing of same so, this temperature must be reduced to about 150-200°C at which the engine will work most efficiency. All the heat produced by the combustion of fuel in the engine cylinders is not converted into useful power at the crankshaft. In this study, a fin is a surface that extends from an object to increase the rate of heat transfer from the environment by increasing convection. Generally fins are called as extended surface. The Conduction, convection or radiation of an object determine the amount of heat transfers. Increasing the temperature difference between the object and the environment, increasing the heat transfer coefficient or increasing the surface area of the object increases the heat transfer. Sometimes it is not economical or it is not feasible to change the first two options. Adding a fin to an object, however increase of the surface area and can sometimes be economical solution to heat transfer problems. These notes provided an introduction to engineering heat transfer.

The removal of excessive heat from system components is essential to avoid the damaging effects of burning or overheating. Therefore the enhancement of heat transfer is an important subject in thermal engineering. The heat transfer from surfaces in general is enhanced by increase in the heat transfer coefficient between surfaces and its surroundings, or by increasing the heat transfer area of the surface. In most cases, the area of heat transfer is increased by utilizing the extended surfaces in the form of fins attached to walls and surfaces. Fins are used to enhance convective heat transfer in a wide range of engineering applications and offer a practical means for achieving a large total heat transfer surface area. Fins with various thickness and modified fins are modelled. These modified fins are analysed with high thermal conductivity materials to select the suitable model with high heat transfer rate.

2 Modelling of fins

2.1 Material properties

2.1.1 Aluminium alloy

Density	2.77e-6 kg /mm ³
Coefficient of thermal expansion	2.3e-5 /K
Specific heat	8.75e+5 MJ /kg K
Thermal conductivity	202 W/m K

2.1.2 Copper alloy

Density	8.3e-6 kg /mm ³
Coefficient of thermal expansion	1.8e-5 /K
Specific heat	3.85e+5 MJ /kg K
Thermal conductivity	401 W/m K

2.1.3 Magnesium alloy

Density	1.8e-006 kg /mm ³
Coefficient of thermal expansion	2.6e-005 /K
Specific heat	1.024e+6 MJ /kg K
Thermal conductivity	156 W/m K

2.2 Designing of fins

Model: Apache 160cc

2.2.1 Fin with 2mm thickness

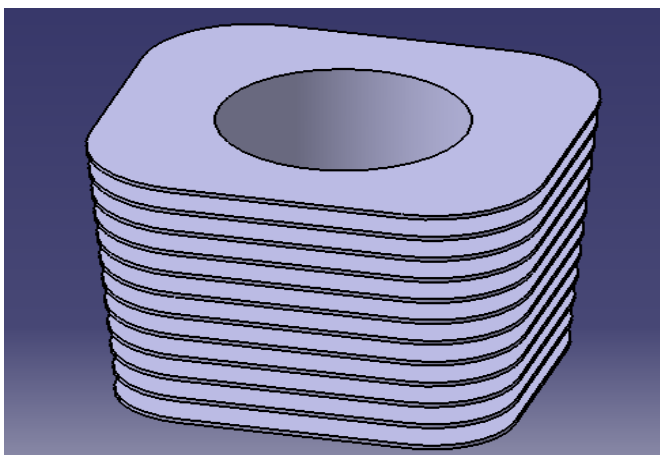

2.2.3 Fin with 2.25mm thickness

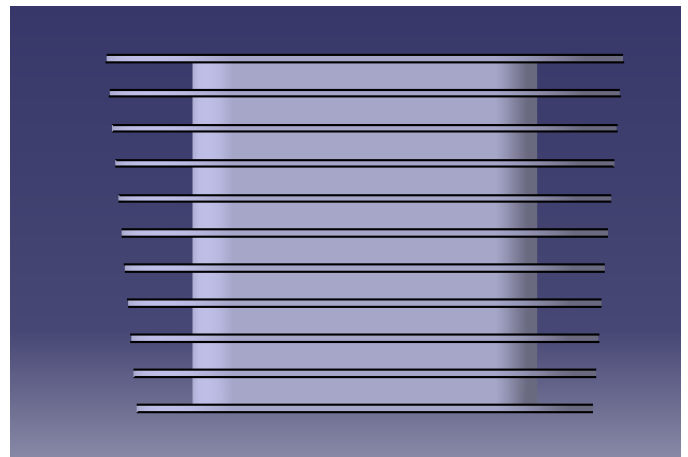

2.2.4 Fin with 2.5mm thickness

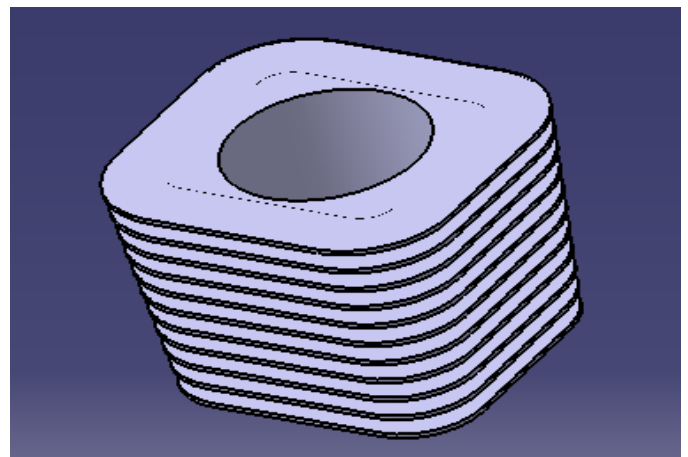

2.2.4 Fin of 2mm thickness with hole notch

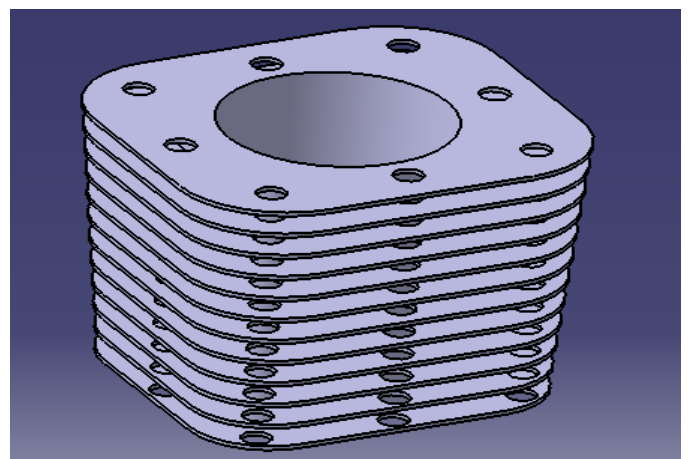

2.2.5 Fin of 2mm thickness with Rectangular notch

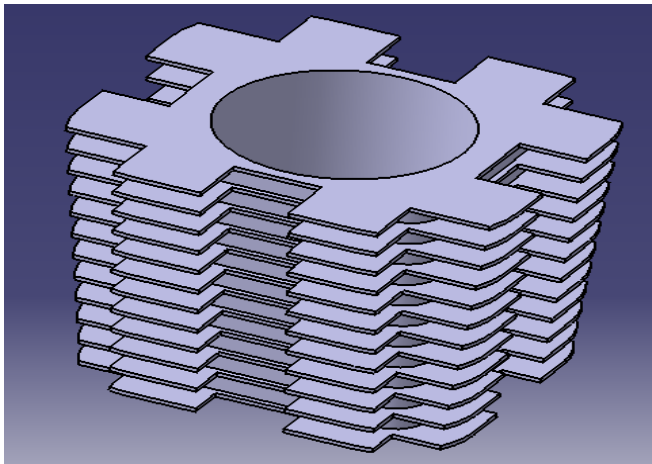

2.2.6 Fin of 2mm thickness with V- notch

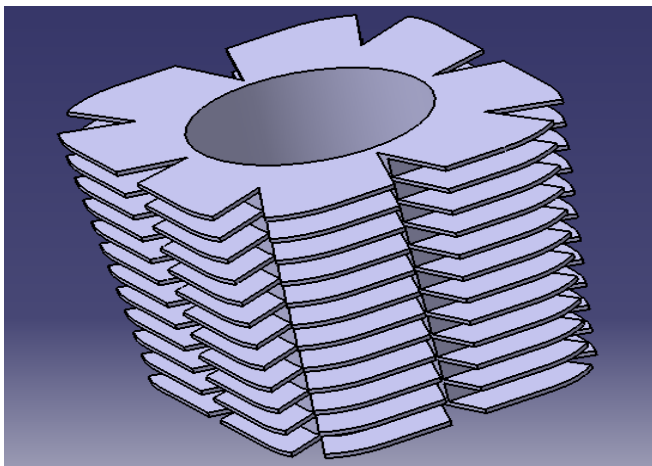

3 Analysis of fin

3.1 Temperature analysis

3.1.1 Temperature analysis of fin of 2mm thickness with aluminium alloy

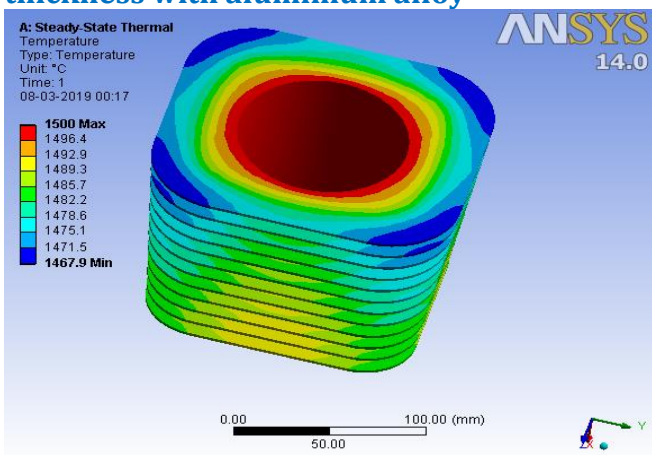

3.1.2 Temperature analysis of fin of 2mm thickness with copper alloy

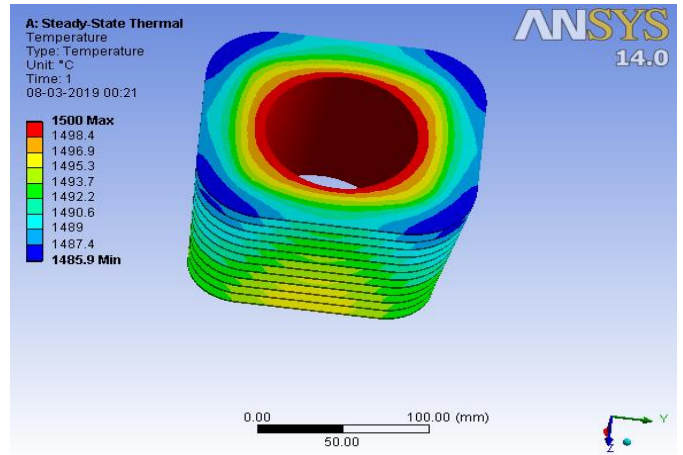

3.1.3 Temperature analysis of fin of 2mm thickness with magnesium alloy

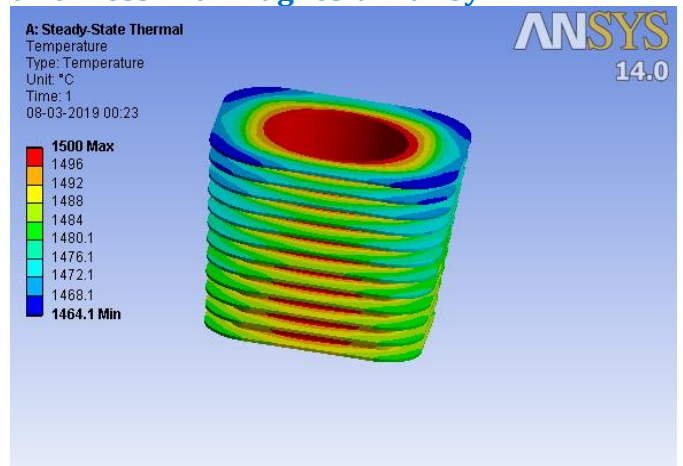

3.1.4 Temperature analysis of fin of 2mm thickness with aluminium alloy for hole notch

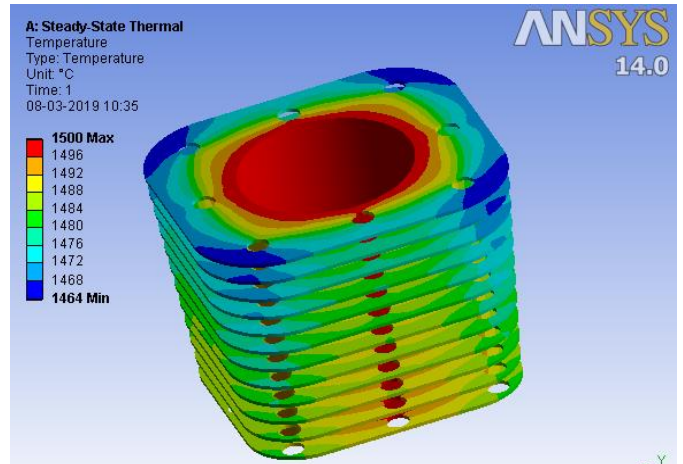

3.1.5 Temperature analysis of fin of 2mm thickness with copper alloy for hole notch

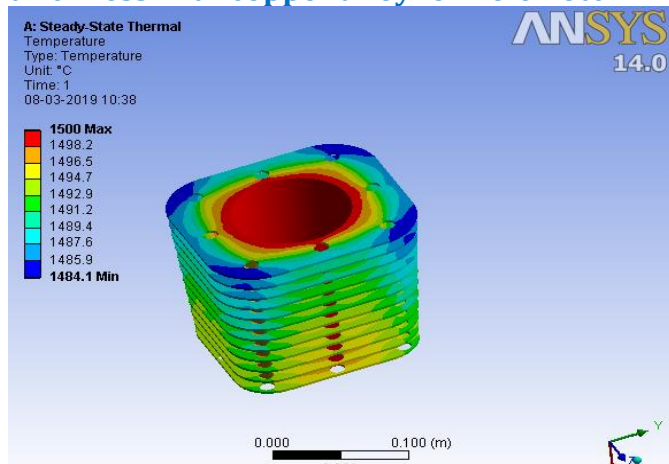

3.1.8 Temperature analysis of fin of 2mm thickness with aluminium alloy for V-notch

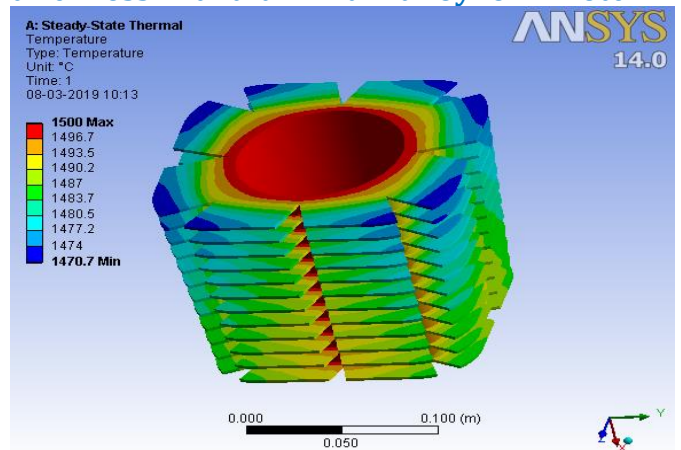

3.1.6 Temperature analysis of fin of 2mm thickness with aluminium alloy for rectangular notch

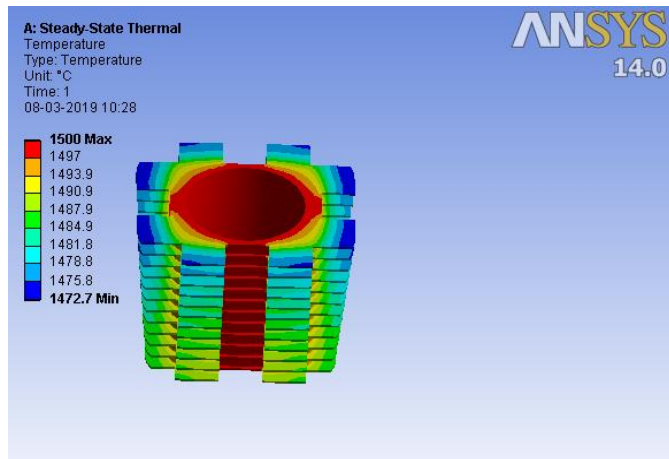

3.1.9 Temperature analysis of fin of 2mm thickness with copper alloy for V-notch

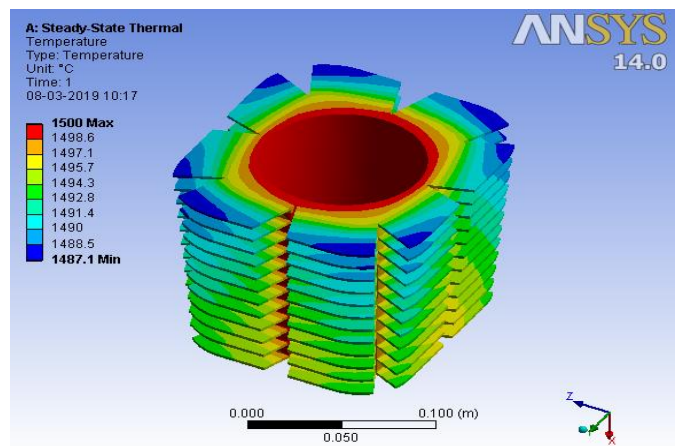

3.1.7 Temperature analysis of fin of 2mm thickness with copper alloy for rectangular notch

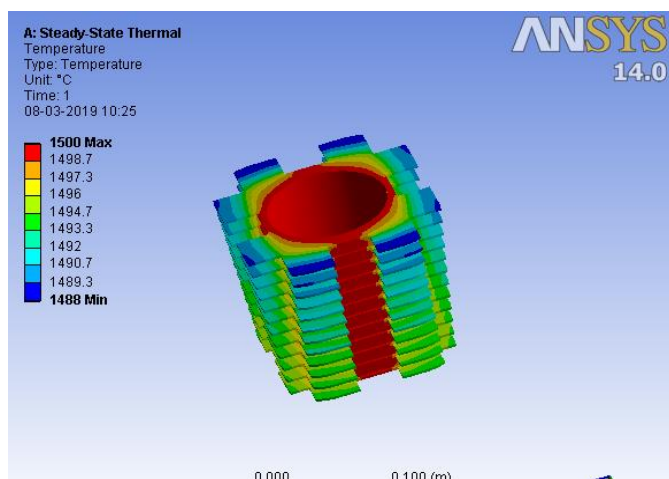

4 Results and discussion

4.1 Analysis table for various thickness of fins and configuration

Here The table contain the temperature variation's and heat flux for all materials for the fin body with various thickness and modifies models. "A" refers to aluminium alloy. "B" refers to copper alloy. "C" refers to magnesium alloy.

In this analysis tables, Fin with thickness of 2mm, 2.25mm, 2.5mm is analyzed and compared. Similarly fins with holes, rectangular notches, V-notch also analyzed in the following tables.

4.1.1 Analysis of fins with 2mm of thickness

MATERIAL	TEMPERATURE (K)		TOTAL HEAT FLUX (W/mm ²)	
	Max	Min	Max	Min
A	1500	1167.2	2.24e5	2147.2
B	1500	1485	2.26e5	2183.9
C	1500	1464.1	2.24e5	2139.2

4.1.2 Analysis of fins with 2.25mm of thickness

MATERIAL	TEMPERATURE (K)		TOTAL HEAT FLUX (W/mm ²)	
	Max	Min	Max	Min
A	1500	1416.5	1.09e5	5028.1
B	1500	1486.5	2.03e5	5179.1
C	1500	1466.7	2.01e5	5139.7

4.1.3 Analysis of fins with 2.5mm of thickness

MATERIAL	TEMPERATURE (K)		TOTAL HEAT FLUX (W/mm ²)	
	Max	Min	Max	Min
A	1500	1472.3	1.82e5	3865.8
B	1500	1487.8	1.83e5	3907.9
C	1500	1469	1.82e5	3856.7

4.1.4 Analysis of fins with 2mm of thickness with hole notch

MATERIAL	TEMPERATURE (K)		TOTAL HEAT FLUX (W/mm ²)	
	Max	Min	Max	Min
A	1500	1464	2.90e5	1168.4
B	1500	1484.1	2.94e5	1173.2
C	1500	1459.7	2.90e5	1167.5

4.1.5 Analysis of fins with 2mm of thickness with rectangular notch

MATERIAL	TEMPERATURE (K)		TOTAL HEAT FLUX (W/mm ²)	
	Max	Min	Max	Min
A	1500	1472.7	3.12e5	4567
B	1500	1488	3.15e5	4569.9
C	1500	1469.5	3.11e5	4566.4

4.1.6 Analysis of fins with 2mm of thickness with V- notch

MATERIAL	TEMPERATURE (K)		TOTAL HEAT FLUX (W/mm ²)	
	Max	Min	Max	Min
A	1500	1470.7	2.68e5	3110.9
B	1500	1487.1	2.71e5	3152.2
C	1500	1467.2	2.68e5	3102.2

4.2 Results

It is proved that the heat transfer rate is high, whenever the surface area is increased. Here surface area is increased with increasing in thickness of fin from 2mm to 2.5mm. While analysis the thickness of 2mm fin body, copper alloy has high heat transfer with 1485 K than Aluminium alloy with 1167.2 K. While considering the 2.25mm thickness, copper alloy has high transfer with 1486.5 K than aluminium alloy with 1416.5 K. Similarly copper alloy has high heat transfer in all modifications such as fins with holes, rectangular notches and V-notch. It is shown in above tables.

5 Conclusions

It is concluded that fin with increasing thickness and providing notch in the fin body has given the high heat transfer than the existing fin with 2mm thickness in Apache 160cc. Copper alloy has a high impact on the results. Fin with rectangular notch has high heat transfer than fin with hole and V-notch. The heat transfer rate increases after changing the fin shape. Because the geometry of the fin is not uniform, the turbulence of the flowing air increases, resulting in more heat transfer. In future it may be improved by providing extensions on the fin and designing curved shape which may increase in heat transfer rate.

References

[1] G.BahadurVali& Krishna Veni "Design/Modelling and Thermal Analysis on Cylinder Head of I.C Engine" International Journal & Magazine of Engineering, Technology, Management and Research, ISSN

No. 2348-4845 Volume No.03 (2016), Issue No.05 (may)

[2] ParmarVivekjayeshbhai"A Review - Improving the Efficiency of IC Engine Fins by Varying its Material and Shape" Vol-4 Issue-1 (2018) IJARIE-ISSN(O)-2395-4396

[3] Partner L. Ndlovu and Raseelo J. Moitsheki "Analytical Solutions for Steady Heat Transfer in Longitudinal Fins with Temperature-Dependent Properties" Volume 2013, Article ID 273052, 14 pages

[4] G. Babu, M. Lavakumar "Heat Transfer Analysis and Optimization of Engine Cylinder Fins of Varying Geometry and Material" IOSR Journal of Mechanical and Civil Engineering (IOSR-JMCE)e-ISSN: 2278-1684,p-ISSN: 2320-334X, Volume 7, Issue 4 (Jul. - Aug. 2013), PP 24-29

[5] Mr. Uday Mishra "A Review Paper on rising the potency of IC Engine Fins by varied its Material and form" IPASJ International Journal of Information Technology (IIJIT)Volume 5, Issue 6, June 2017

[6] Mr. Mehul S. Patel¹, Mr. N.M.Vora²"Thermal Analysis of I C Engine cylinder fins array using CFD International Journal of Advance Engineering and Research Development" (IJAERD) Volume 1,Issue 5,May 2014, e-ISSN: 2348 - 4470 , print-ISSN:2348-6406

[7] VikashKumar, Dr. S K Jain, Dr. Sukul Lomash"A Review Paper on Improving the Efficiency of IC Engine Fins by Varying its Material and Shape. "International Journal of Recent Development in Engineering and Technology".

[8] Akash M Vyas, Ruchir Parikh "Analysis of I.C. Engine Fins for Effective Cooling Performance" IJSTE - International Journal of Science Technology & Engineering | Volume 5 | Issue 1 | July